

Optielijst		
nummer	naam	formaat
OT-01	voorblad	A3
OT-02	uitbouw 1200mm / uitbouw 2400mm / trapkast blok A	A3
OT-03	uitbouw 1200mm / 2400mm / trapkast blok B en C	A3
OT-04	uitbouw 1200mm / uitbouw 2400mm / trapkast blok D, E en G (rechter deel)	A3
OT-05	uitbouw 1200mm / 2400mm / trapkast blok F en G (linker deel)	A3
OT-06	achtergevel opties blok A	A3
OT-07	achtergevel opties blok B en C	A3
OT-08	achtergevel opties blok D, E en G (rechter deel)	A3
OT-09	achtergevel opties blok F en G (linker deel)	A3
OT-10	vergrootte badkamer 300mm en 600mm en inloopkast blok A	A3
OT-11	extra slaapkamer blok B en C	A3
OT-12	badkamer verdieping 2 blok B en C	A3
OT-13	vergrootte berging blok A tm G	A3
OT-14	inloopkast slaapkamer 1	A3



Dura Vermeer Bouw Hengelo BV
 Bosmaatweg 60
 7556 PJ Hengelo
 Postbus 877
 7550 AW Hengelo
 Telefoon: (074) 255 02 55
 E-mail: hengelo.bouw@duravermeer.nl

tek. nr : **OT-01** fase : **3b Verkoop**

gezien : JE datum : 26-03-2024

getekend : MOM gewijzigd :

afmeting : A3 wijzigingsnummer :

project : **De Tippe X2**
 onderdeel: **voorblad**

schaal

status
definitief
 projectnummer
50183130

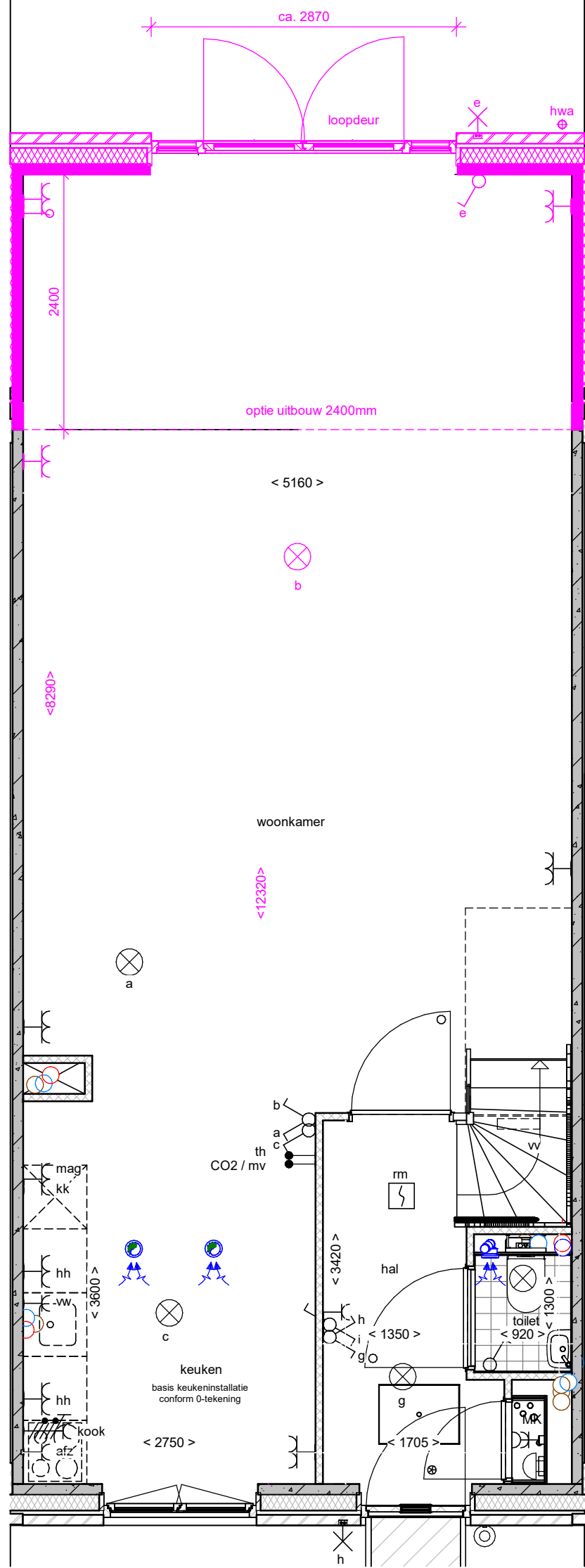
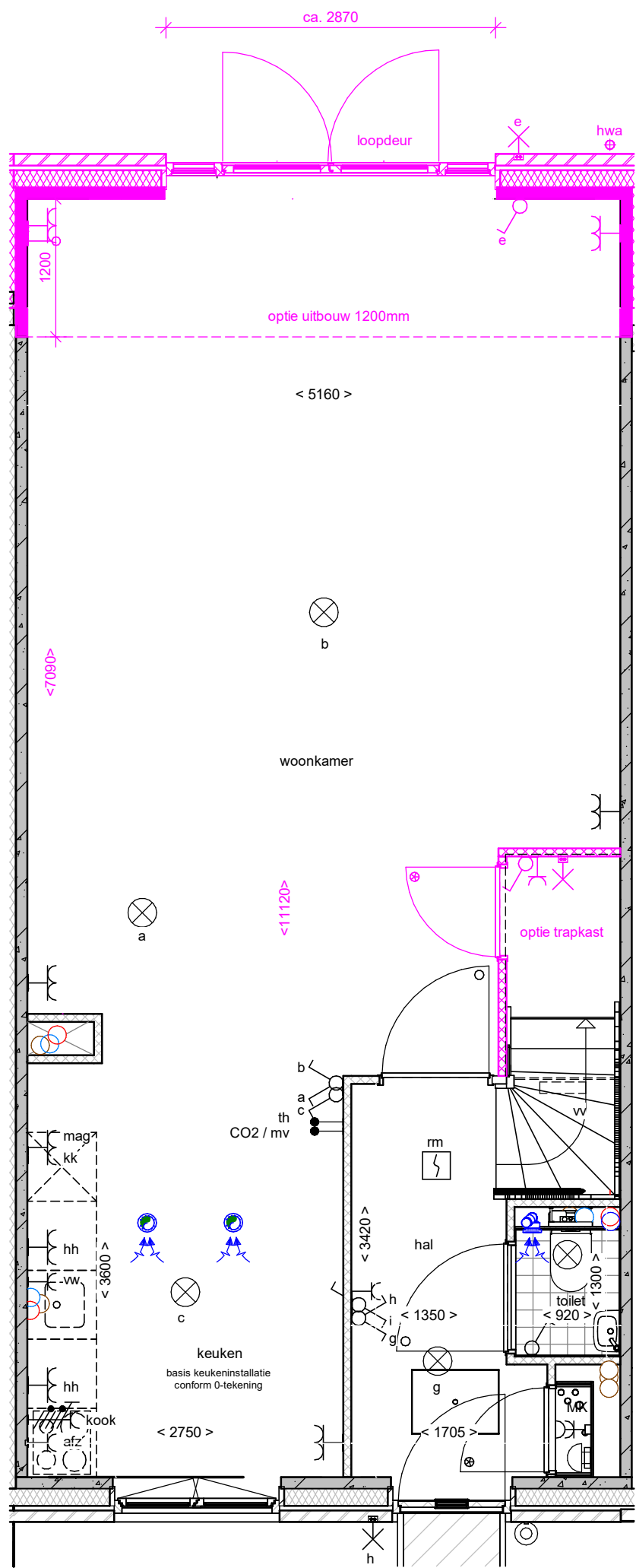

Dura Vermeer Bouw Hengelo BV
 Bosmaatweg 60
 7556 PJ Hengelo
 Postbus 877
 7550 AW Hengelo
 Telefoon: (074) 255 02 55
 E-mail: hengelo.bouw@duravermeer.nl

tek. nr	: OT-02	fase	: 3b Verkoop
gezien	: JE	datum	: 26-03-2024
getekend	: MOM	gewijzigd	:
afmeting	: A3	wijzigingsnummer	:

project : **De Tippe X2**
 onderdeel: **uitbouw 1200mm / uitbouw 2400mm / trapkast blok A**

schaal
 1:50/1:100
 status
 definitief
 projectnummer
 50183130

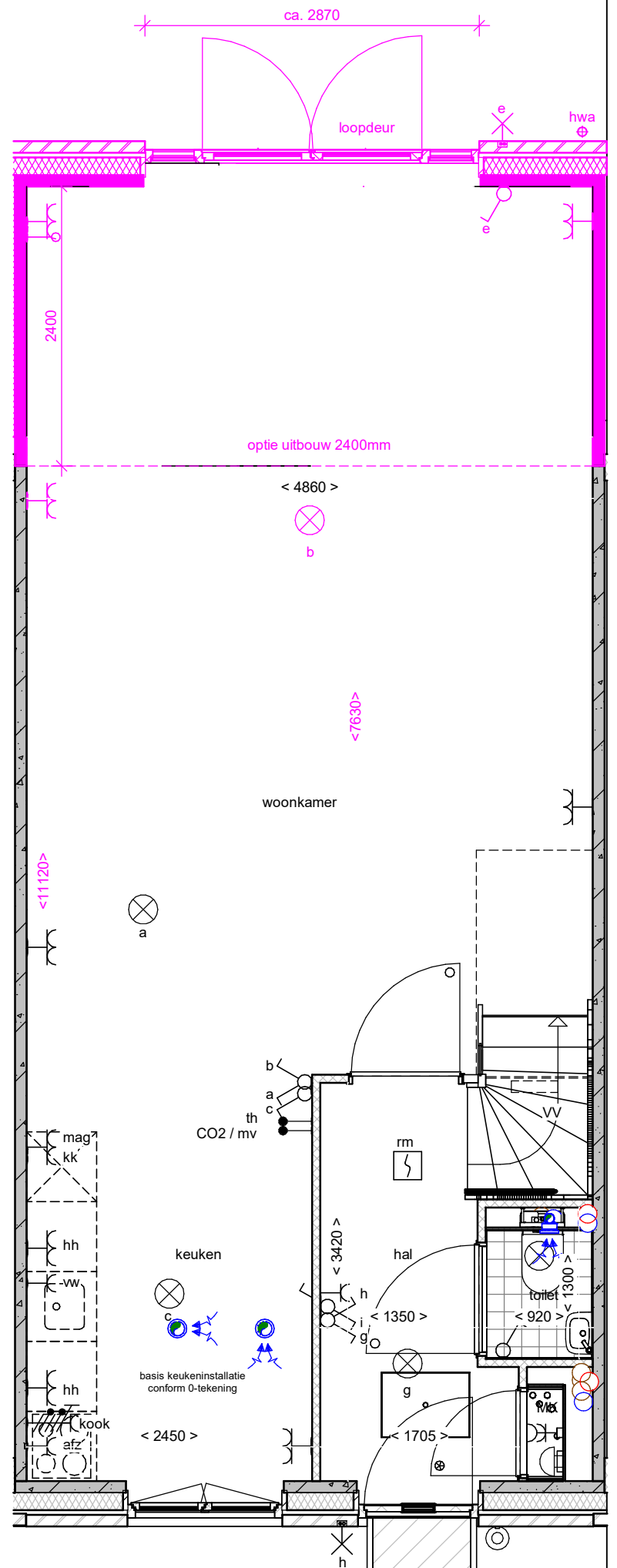
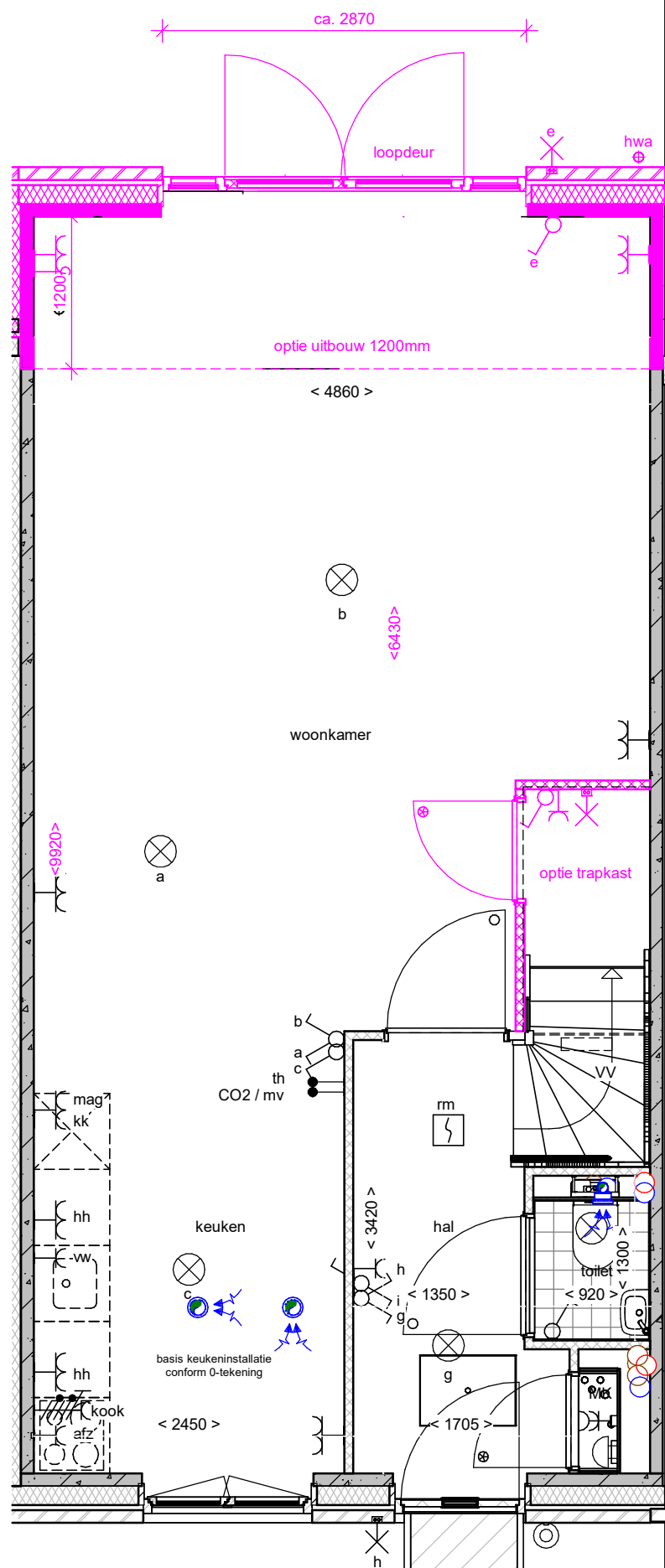

Dura Vermeer Bouw Hengelo BV
 Bosmaatweg 60
 7556 PJ Hengelo
 Postbus 877
 7550 AW Hengelo
 Telefoon: (074) 255 02 55
 E-mail: hengelo.bouw@duravermeer.nl

tek. nr :	OT-03	fase :	3b Verkoop
gezien :	JE	datum :	26-03-2024
getekend :	MOM	gewijzigd :	
afmeting :	A3	wijzigingsnummer :	

project : **De Tippe X2**
 onderdeel: **uitbouw 1200mm / 2400mm / trapkast blok B en C**

schaal
 1:50/1:100
 status
 definitief
 projectnummer
 50183130

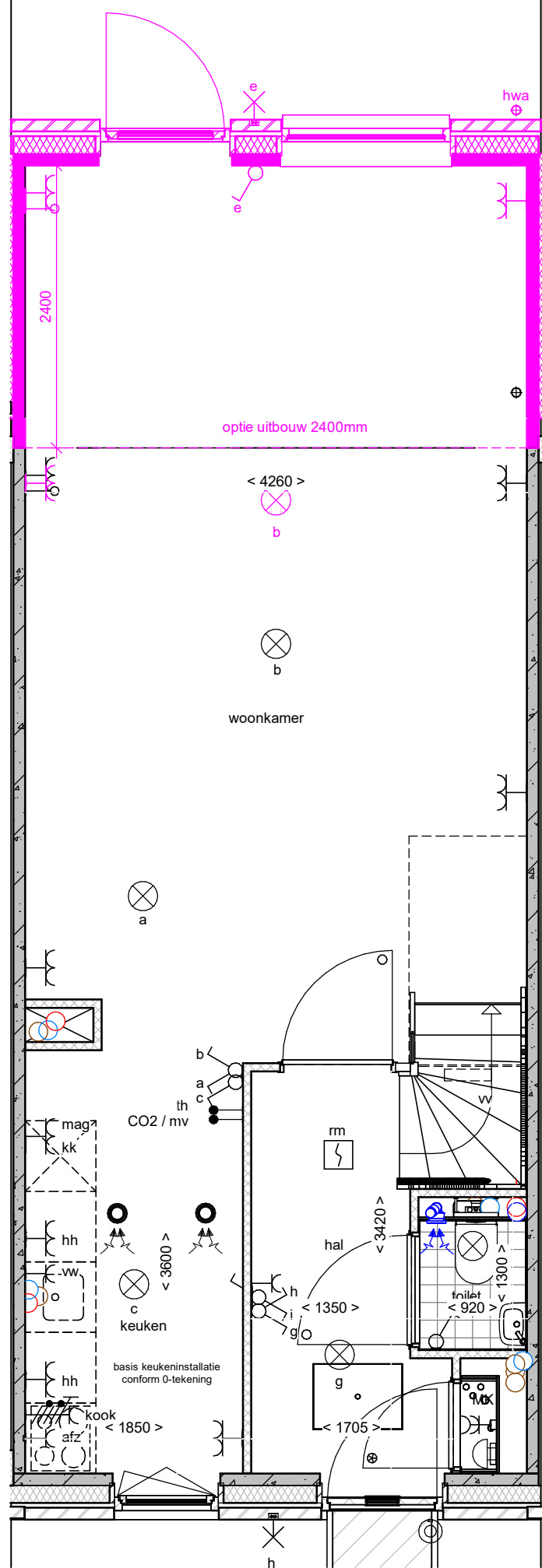
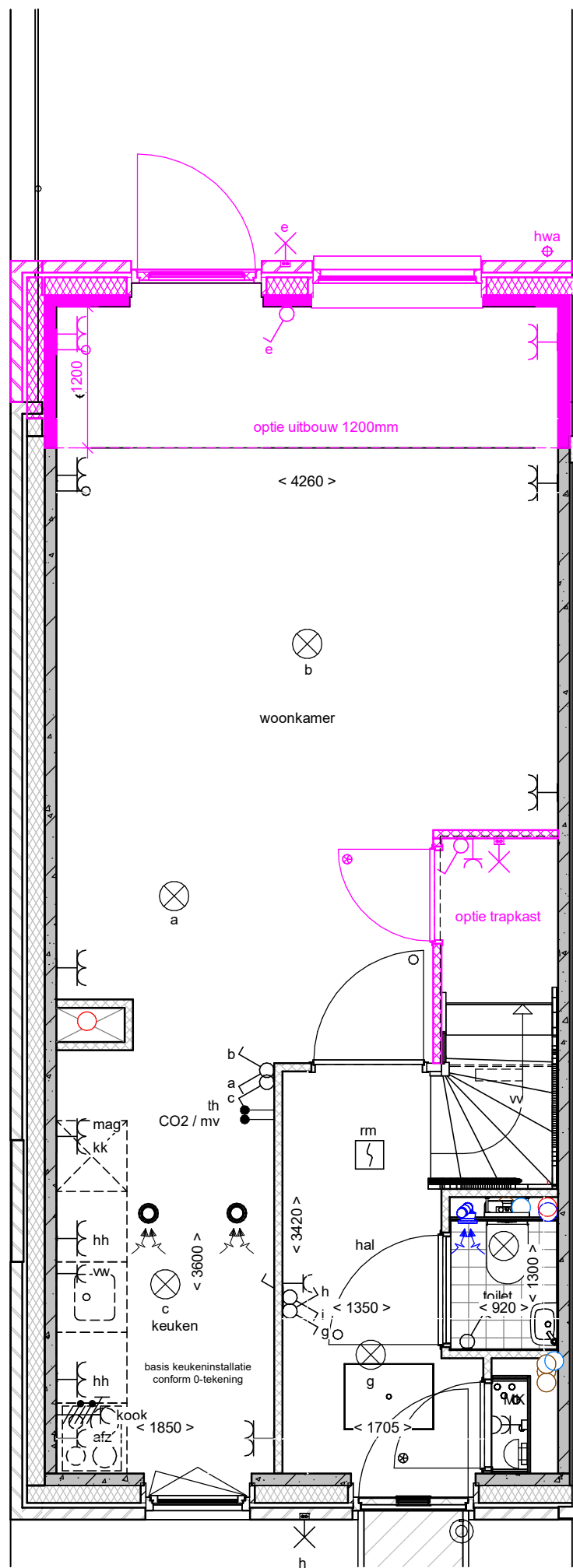

Dura Vermeer Bouw Hengelo BV
 Bosmaatweg 60
 7556 PJ Hengelo
 Postbus 877
 7550 AW Hengelo
 Telefoon: (074) 255 02 55
 E-mail: hengelo.bouw@duravermeer.nl

tek. nr	: OT-04	fase	: 3b Verkoop
gezien	: JE	datum	: 26-03-2024
getekend	: MOM	gewijzigd	:
afmeting	: A3	wijzigingsnummer	:
project	: De Tippe X2		
onderdeel	: uitbouw 1200mm / uitbouw 2400mm / trapkast blok D, E en G (rechter deel)		
		schaal	: 1:50
		status	: definitief
		projectnummer	: 50183130

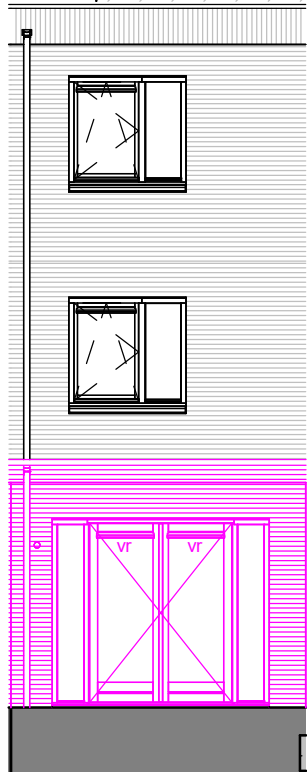
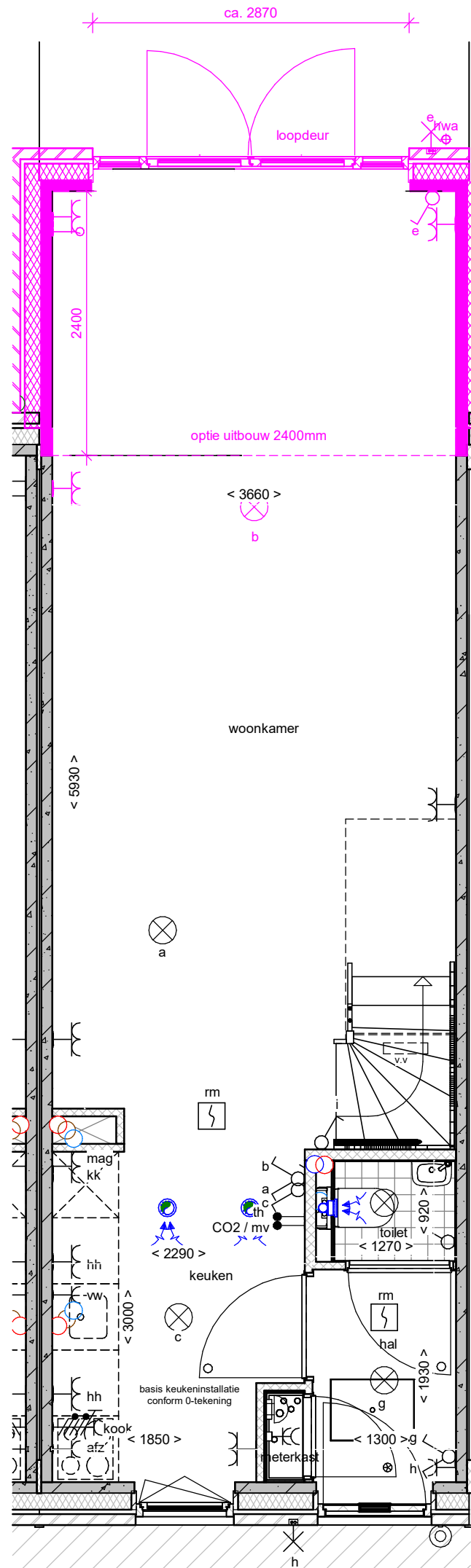
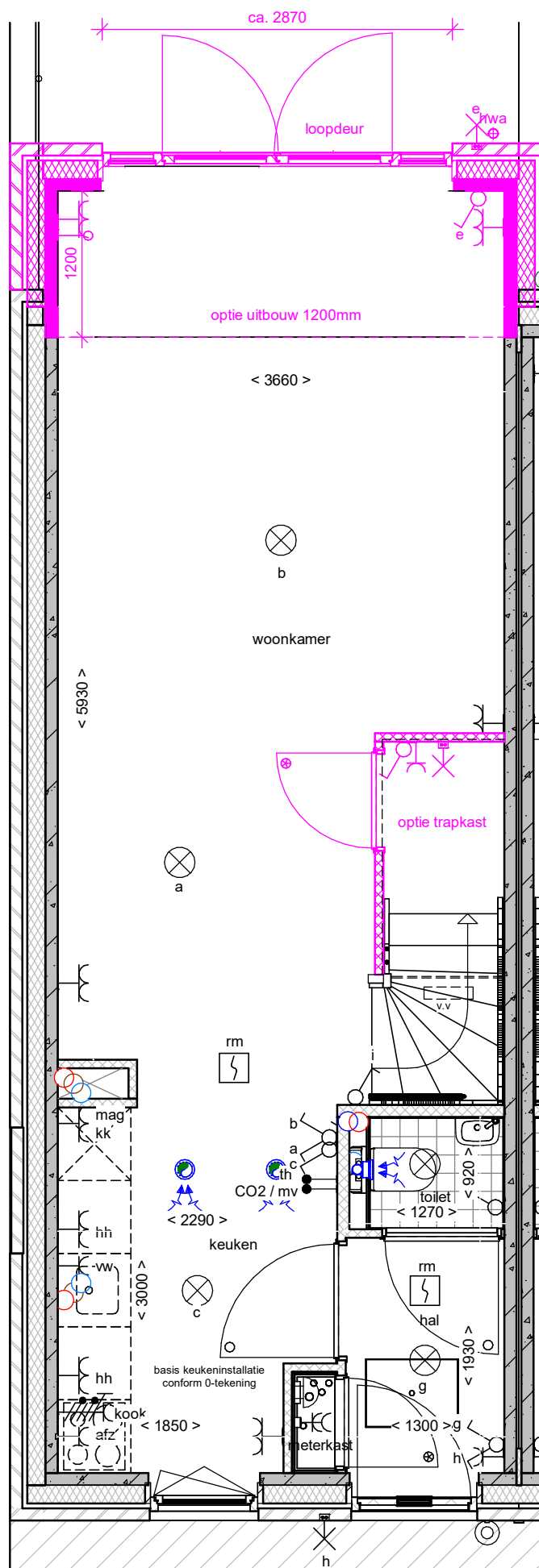

Dura Vermeer Bouw Hengelo BV
 Bosmaatweg 60
 7556 PJ Hengelo
 Postbus 877
 7550 AW Hengelo
 Telefoon: (074) 255 02 55
 E-mail: hengelo.bouw@duravermeer.nl

tek. nr :	OT-05	fase :	3b Verkoop
gezien :	JE	datum :	26-03-2024
getekend :	MOM	gewijzigd :	
afmeting :	A3	wijzigingsnummer :	

project : **De Tippe X2**
 onderdeel: **uitbouw 1200mm / 2400mm / trapkast blok F en G (linker deel)**

schaal
 1:50/1:100
 status
 definitief
 projectnummer
 50183130

optie optie tuindeuren met vast kozijn

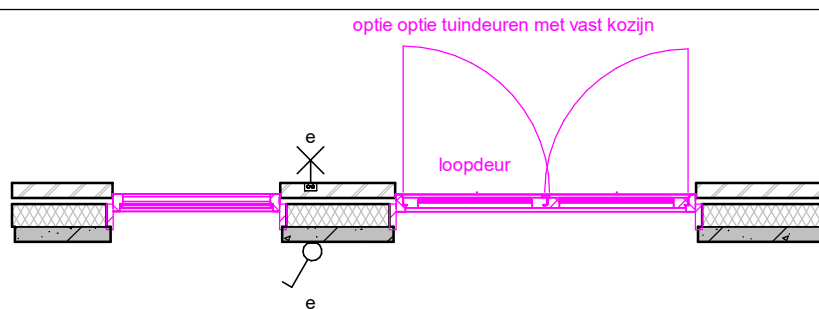
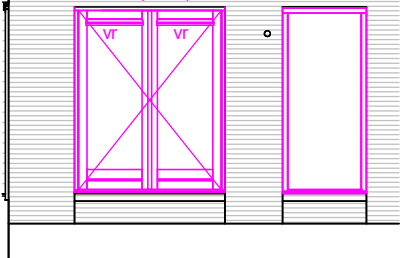

optie tuindeuren met deurkozijn

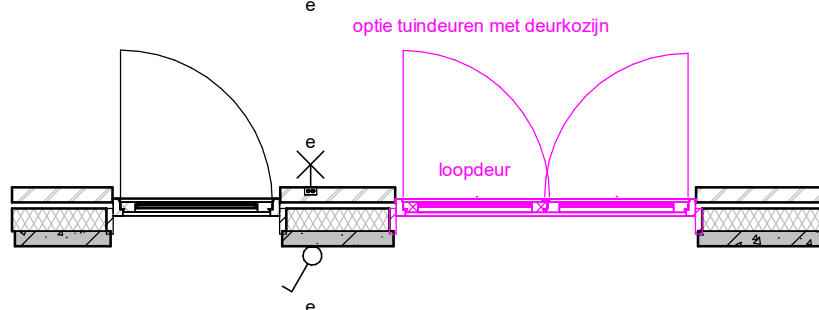
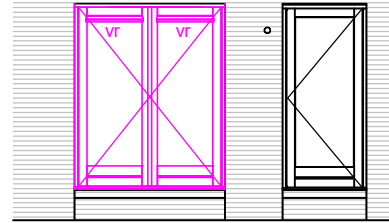

optie tuindeuren met zijlichten

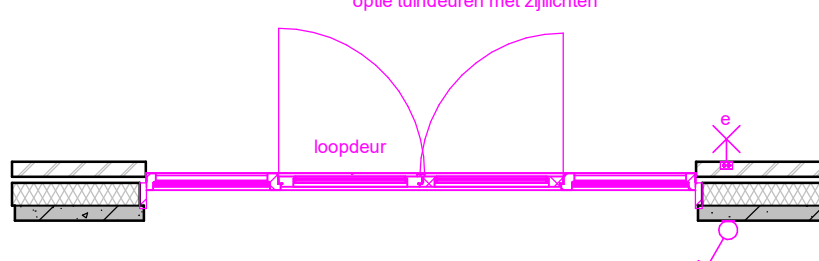
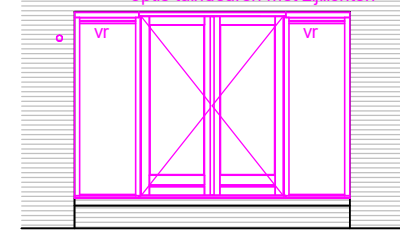

optie 4-delige schuifpui

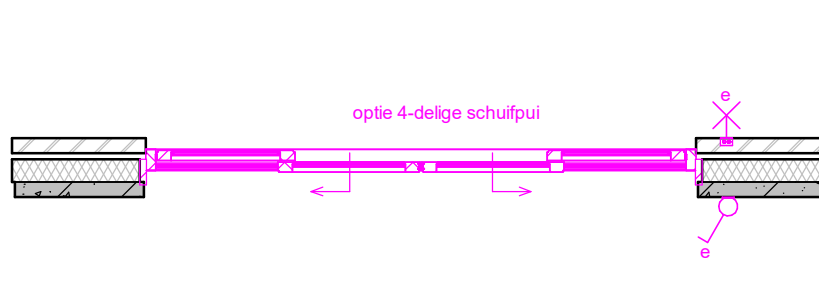
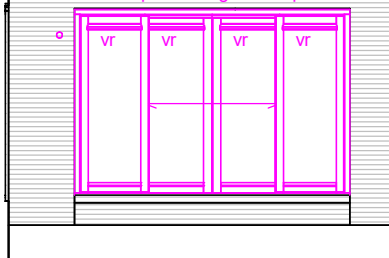

optie 2-delige schuifpui

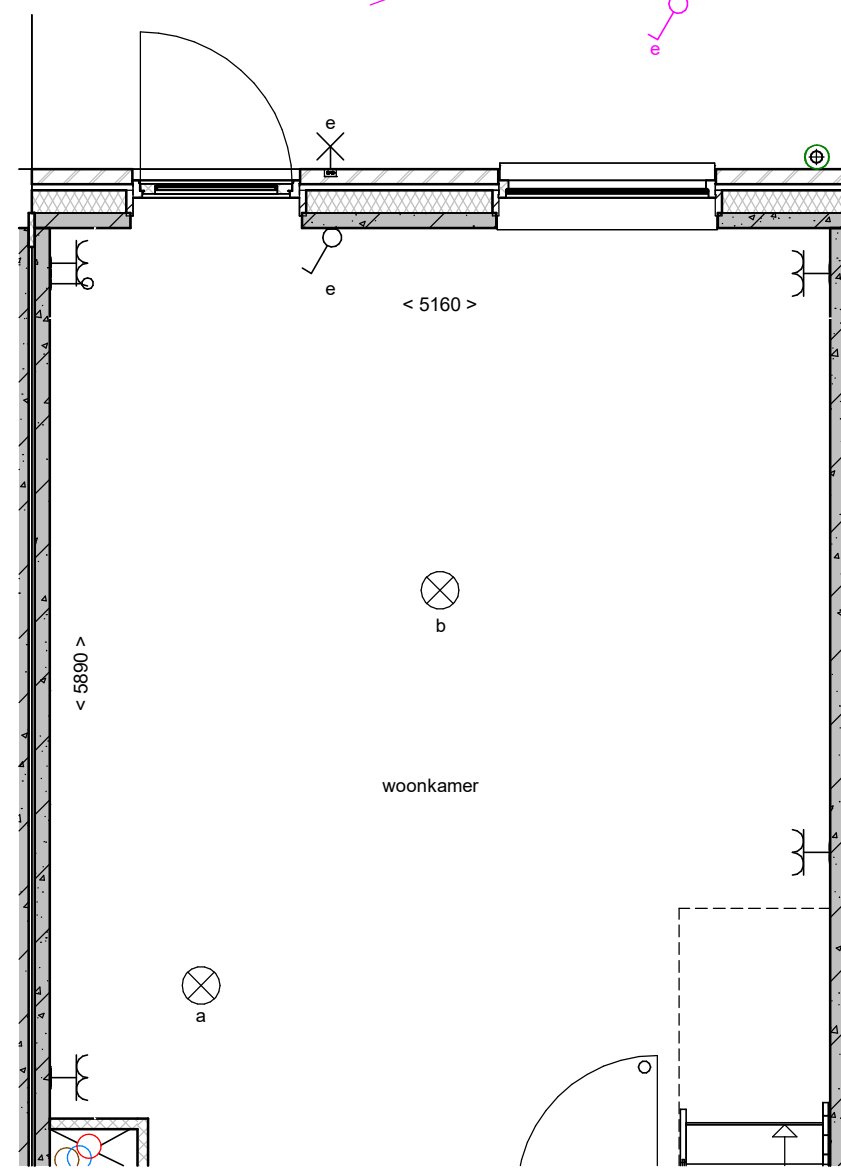
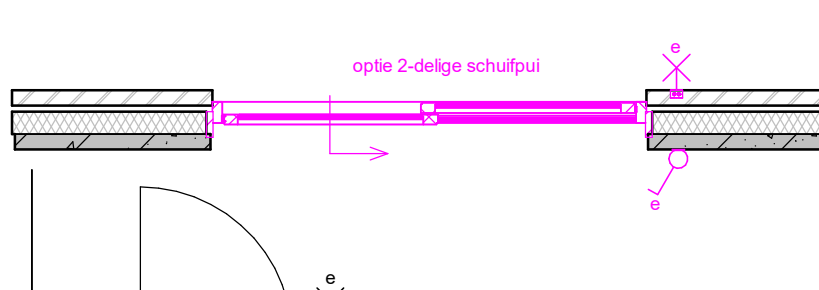
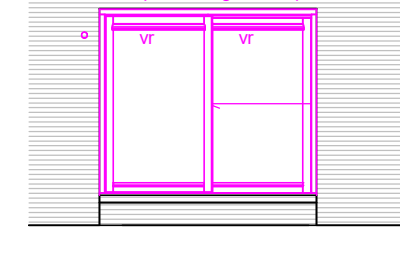

Dura Vermeer Bouw Hengelo BV
Bosmaatweg 60
7556 PJ Hengelo
Postbus 877
7550 AW Hengelo
Telefoon: (074) 255 02 55
E-mail: hengelo.bouw@duravermeer.nl

tek. nr	: OT-06	fase	: 3b Verkoop
gezien	: JE	datum	: 26-03-2024
getekend	: MOM	gewijzigd	:
afmeting	: A3	wijzigingsnummer	:

project : **De Tippe X2**
onderdeel: **achtergevel opties blok A**

schaal
1:50/1:100
status
definitief
projectnummer
50183130

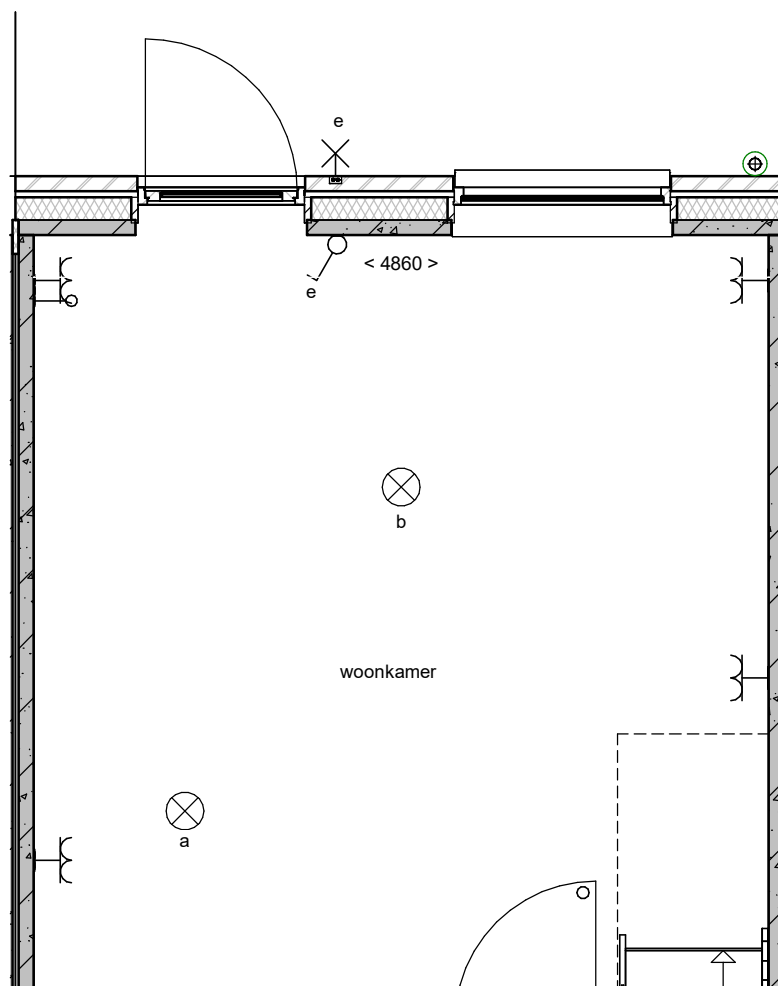
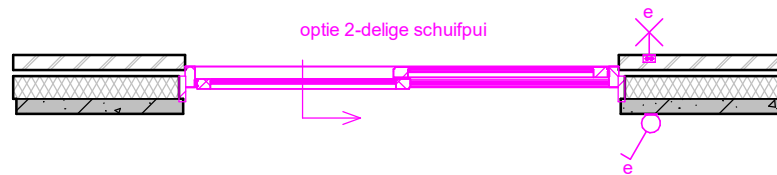
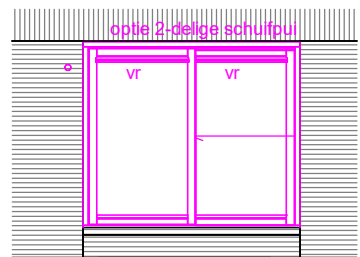
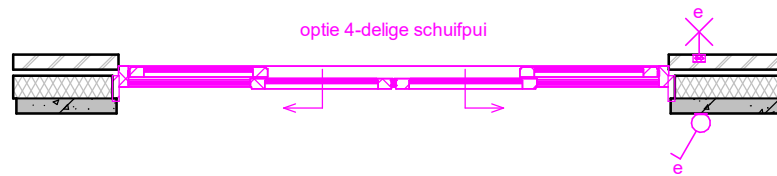
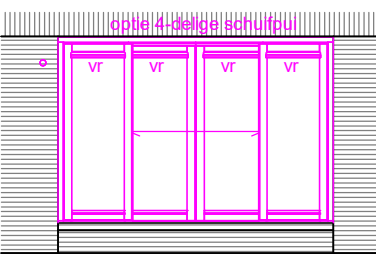
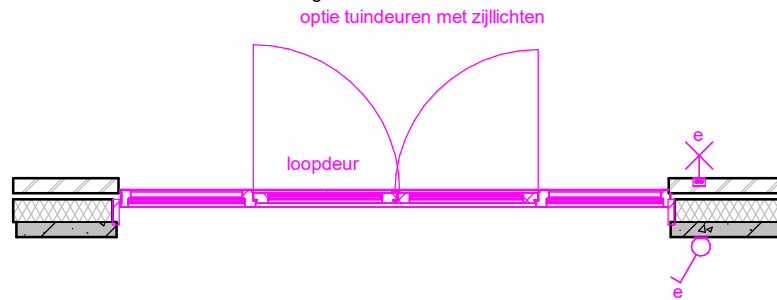
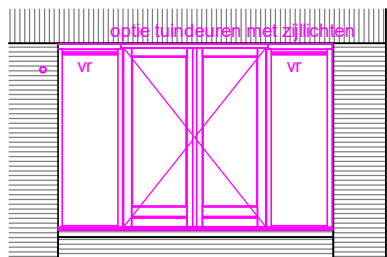
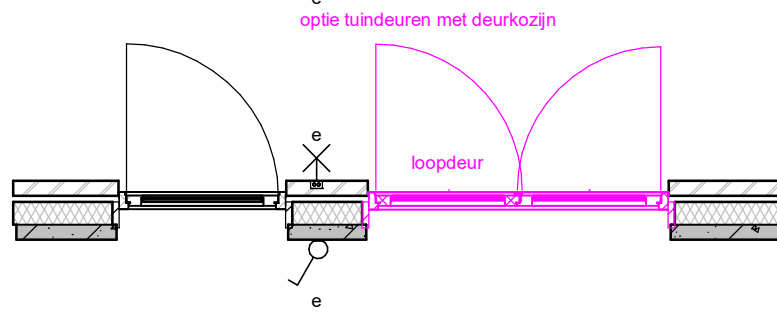
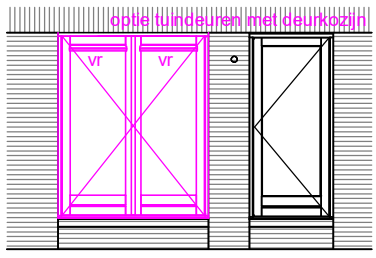
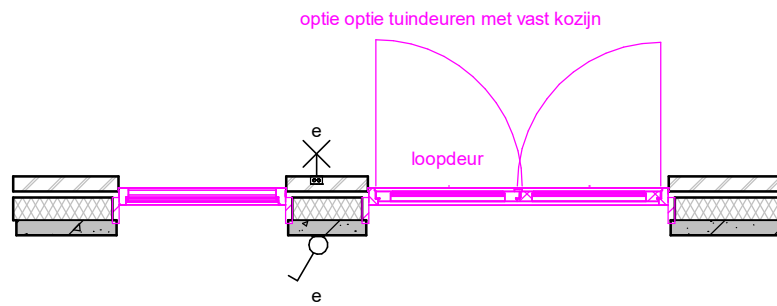
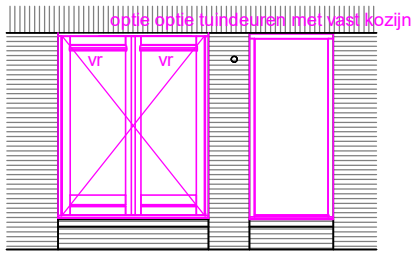

Dura Vermeer Bouw Hengelo BV
 Bosmaatweg 60
 7556 PJ Hengelo
 Postbus 877
 7550 AW Hengelo
 Telefoon: (074) 255 02 55
 E-mail: hengelo.bouw@duravermeer.nl

tek. nr	: OT-07	fase	: 3b Verkoop
gezien	: JE	datum	: 26-03-2024
getekend	: MOM	gewijzigd	:
afmeting	: A3	wijzigingsnummer	:

project : **De Tippe X2**
 onderdeel: **achtergevel opties blok B en C**

schaal
 1:50/1:100
 status
 definitief
 projectnummer
 50183130

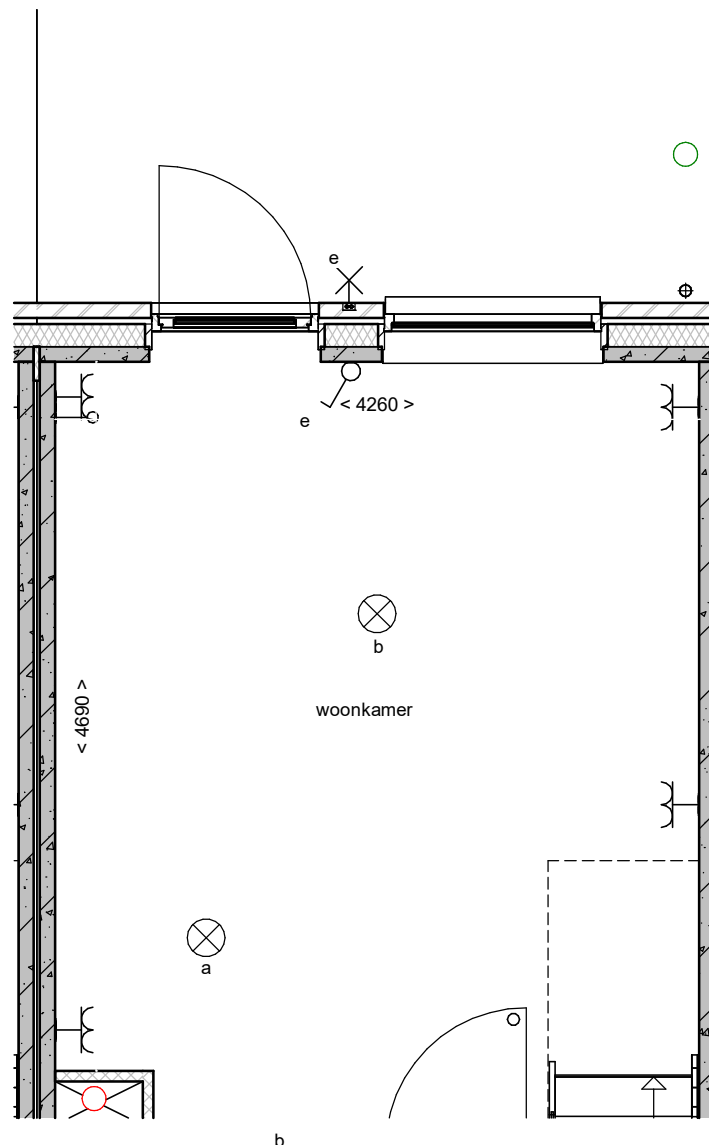
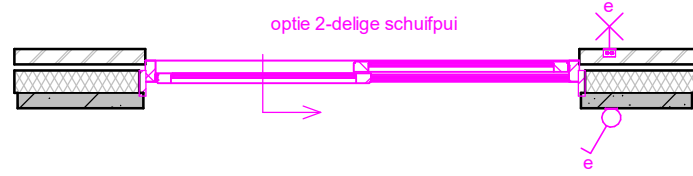
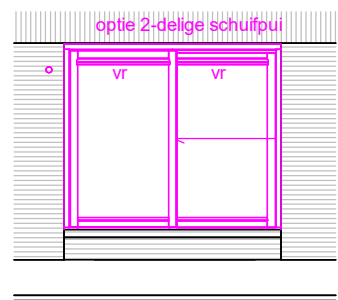
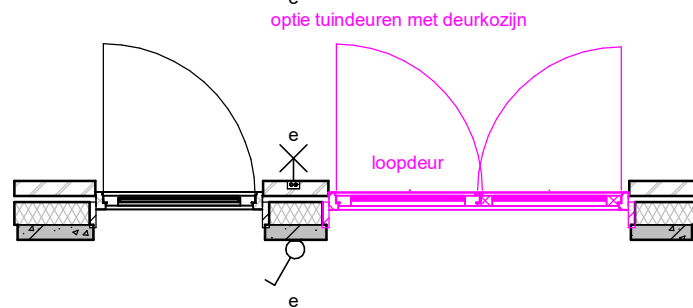
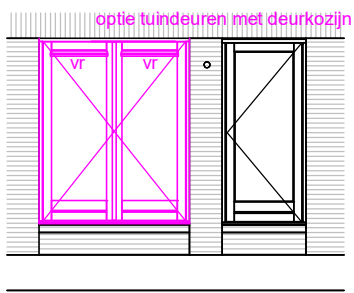
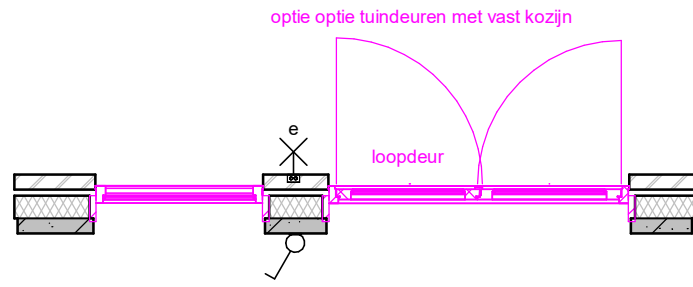
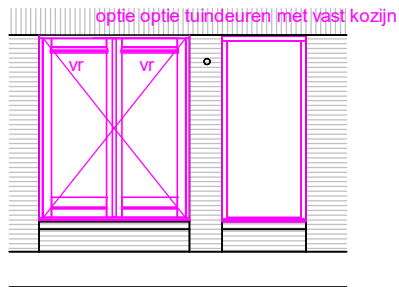

Dura Vermeer Bouw Hengelo BV
 Bosmaatweg 60
 7556 PJ Hengelo
 Postbus 877
 7550 AW Hengelo
 Telefoon: (074) 255 02 55
 E-mail: hengelo.bouw@duravermeer.nl

tek. nr	: OT-08	fase	: 3b Verkoop
gezien	: JE	datum	: 26-03-2024
getekend	: MOM	gewijzigd	:
afmeting	: A3	wijzigingsnummer	:

project : **De Tippe X2**
 onderdeel: **achtergevel opties blok D, E en G (rechter deel)**

schaal
 1:50/1:100
 status
 definitief
 projectnummer
 50183130

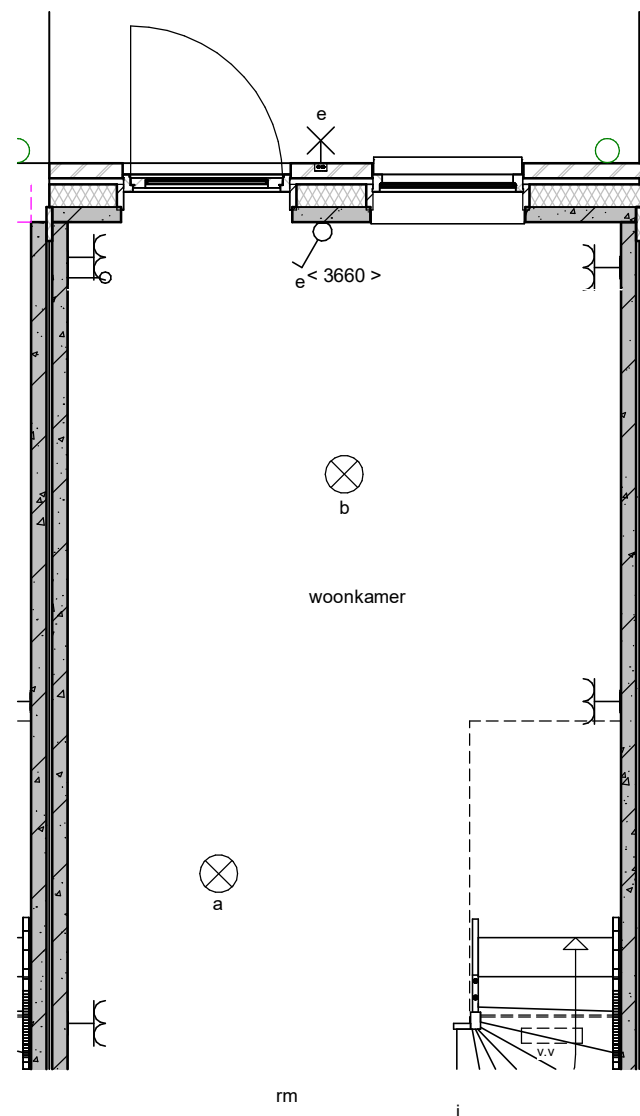
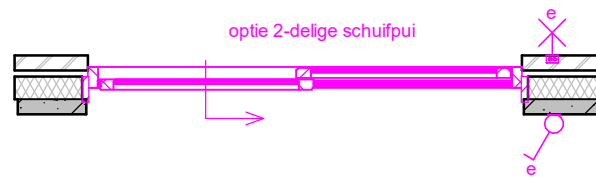
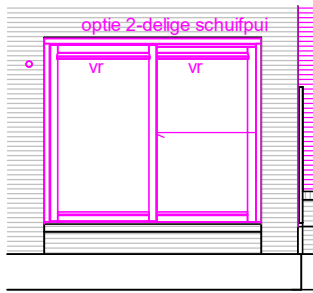

Dura Vermeer Bouw Hengelo BV
 Bosmaatweg 60
 7556 PJ Hengelo
 Postbus 877
 7550 AW Hengelo
 Telefoon: (074) 255 02 55
 E-mail: hengelo.bouw@duravermeer.nl

tek. nr	: OT-09	fase	: 3b Verkoop
gezien	: JE	datum	: 26-03-2024
getekend	: MOM	gewijzigd	:
afmeting	: A3	wijzigingsnummer	:

project : **De Tippe X2**
 onderdeel: **achtergevel opties blok F en G (linker deel)**

schaal
 1:50/1:100
 status
 definitief
 projectnummer
 50183130

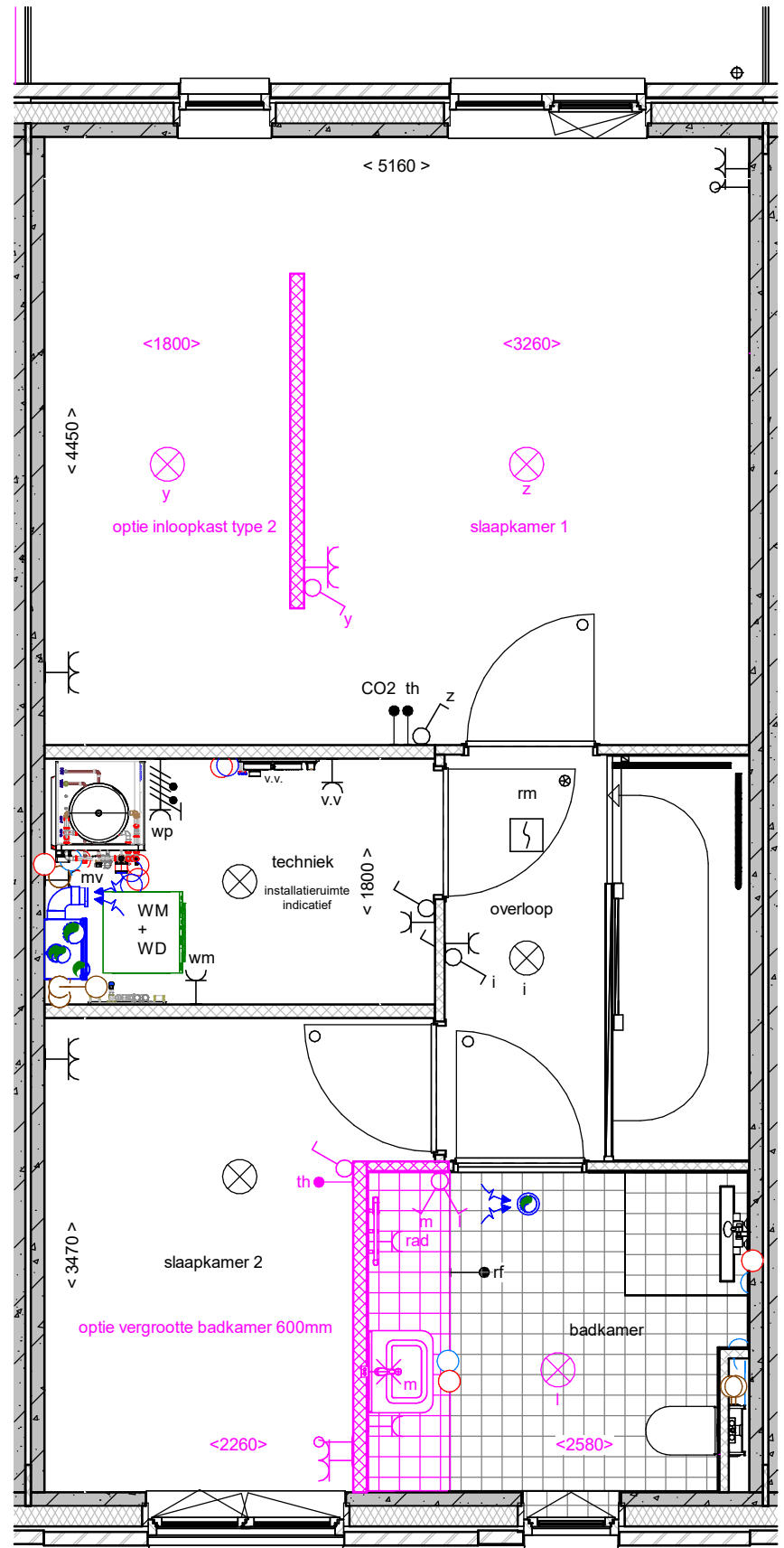
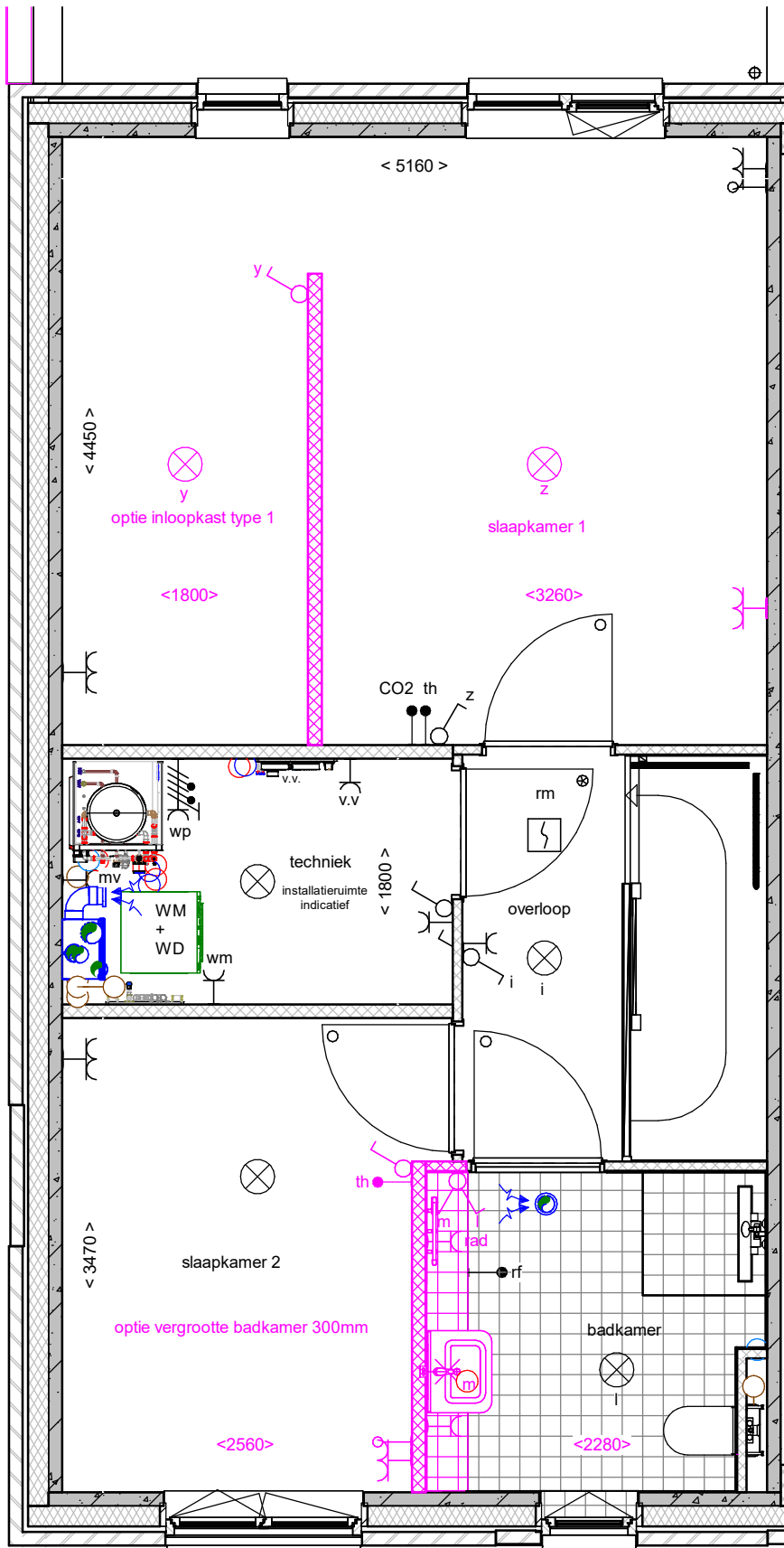

Dura Vermeer Bouw Hengelo BV
 Bosmaatweg 60
 7556 PJ Hengelo
 Postbus 877
 7550 AW Hengelo
 Telefoon: (074) 255 02 55
 E-mail: hengelo.bouw@duravermeer.nl

tek. nr : **OT-10** fase : **3b Verkoop**

gezien : JE datum : 26-03-2024

getekend : MOM

gewijzigd :

afmeting : A3

wijzigingsnummer :

project : **De Tippe X2**
 onderdeel: **vergrootte badkamer 300mm en 600mm en inloopkast blok A**

schaal
 1:50
 status
 definitief
 projectnummer
 50183130

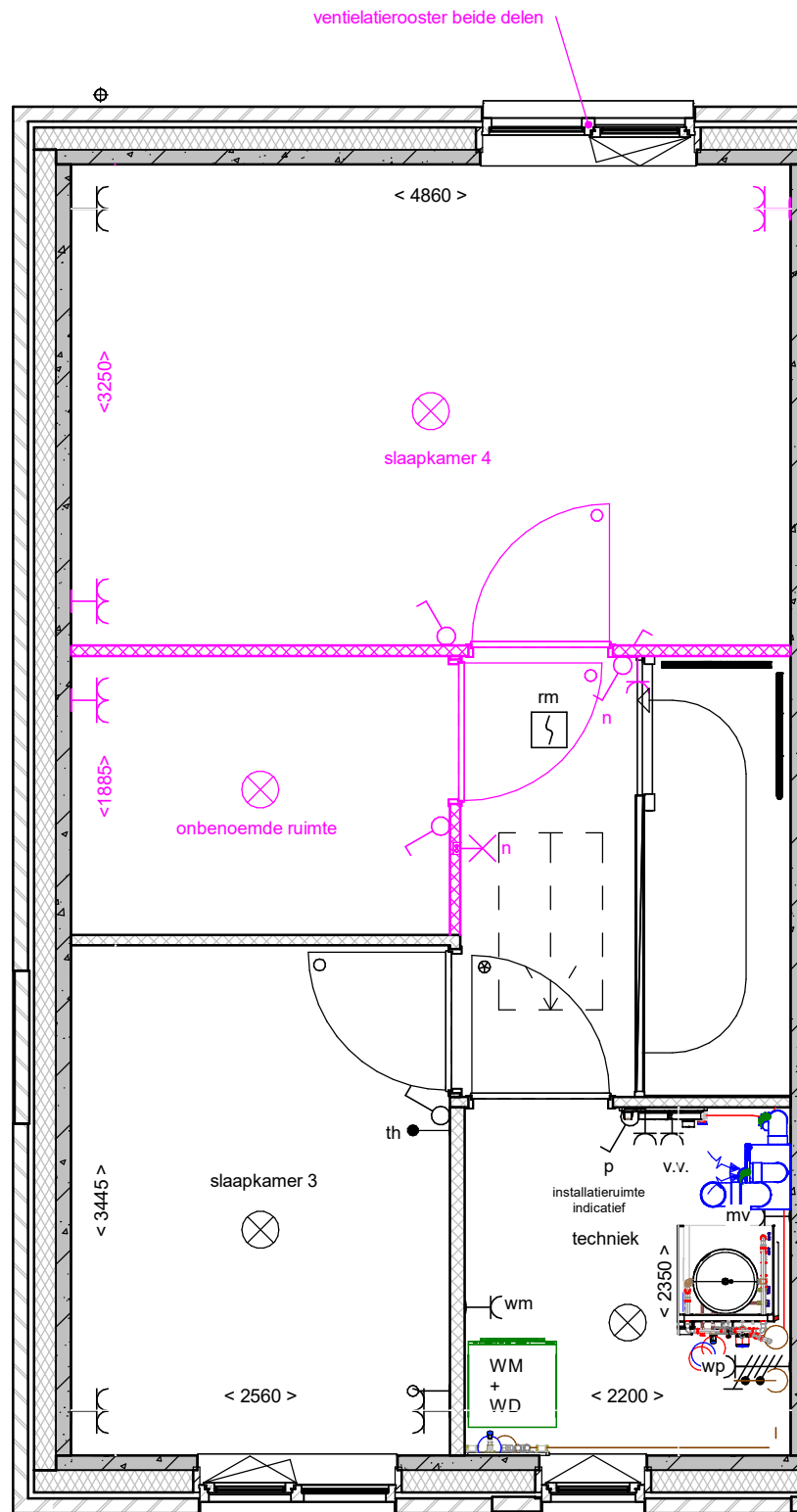

Dura Vermeer Bouw Hengelo BV

Bosmaatweg 60
7556 PJ Hengelo
Postbus 877
7550 AW Hengelo
Telefoon: (074) 255 02 55
E-mail: hengelo.bouw@duravermeer.nl

tek. nr : **OT-11** fase : **3b Verkoop**

gezien : JE datum : 26-03-2024

getekend : MOM gewijzigd :

afmeting : A3 wijzigingsnummer :

project : **De Tippe X2**

onderdeel: **extra slaapkamer blok B en C**

schaal
1:50
status
definitief
projectnummer
50183130

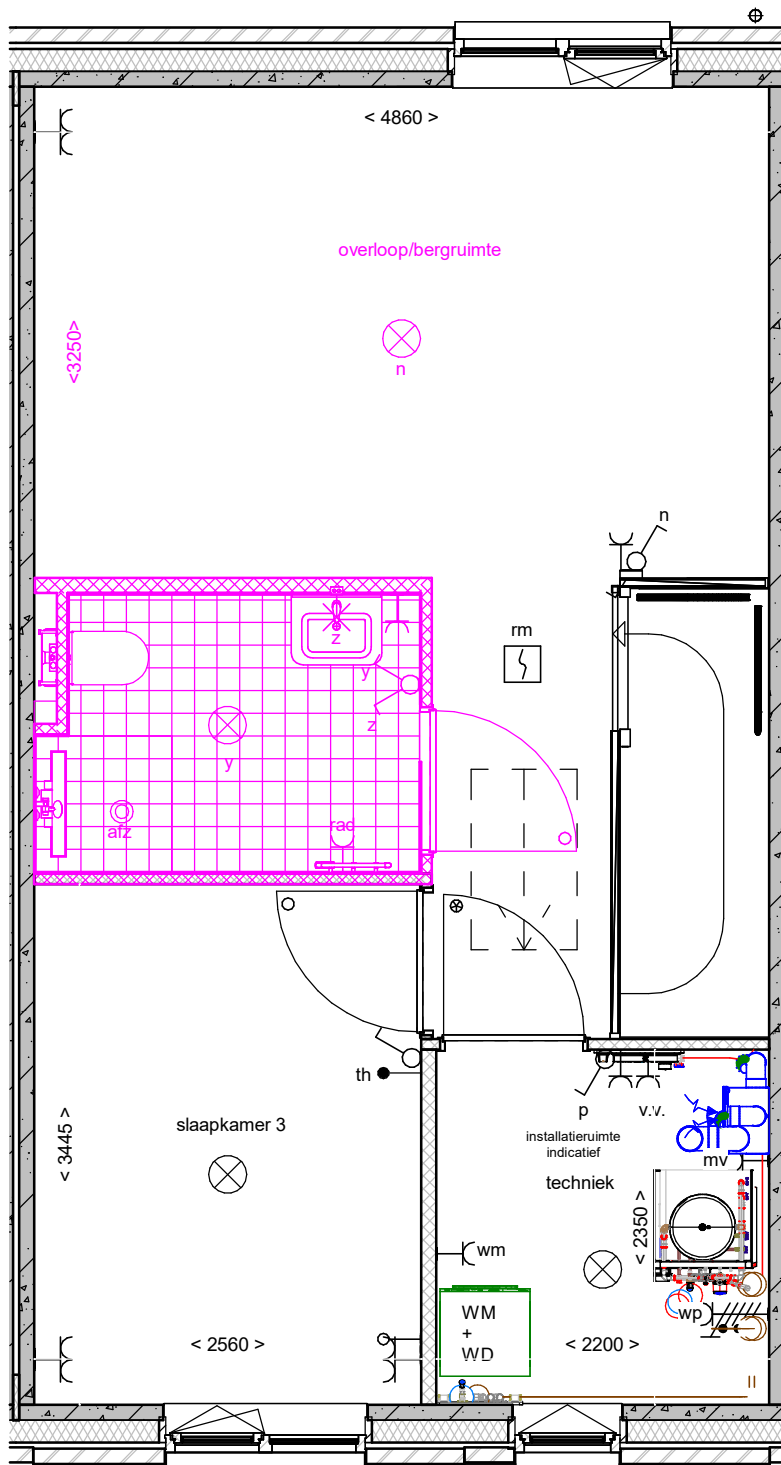

2e verdieping

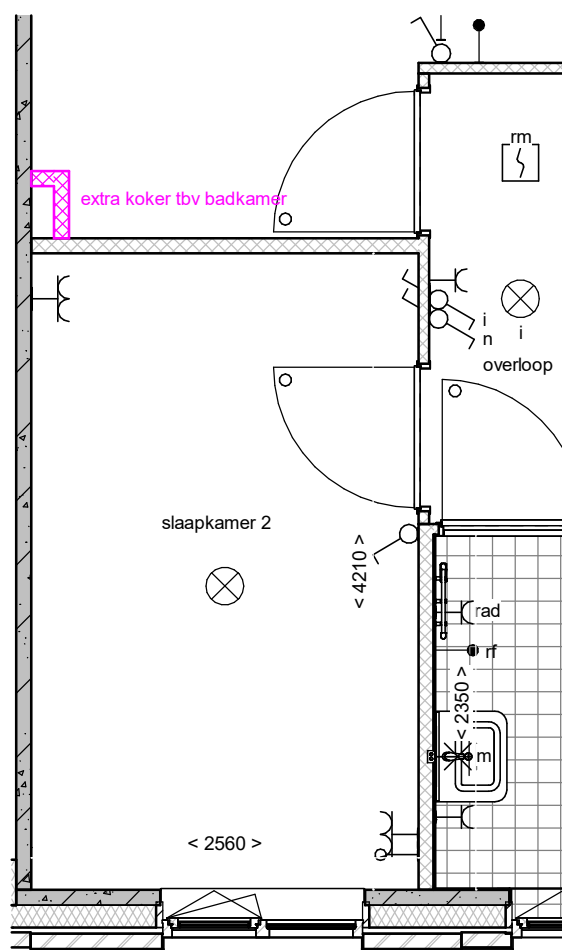

1e verdieping

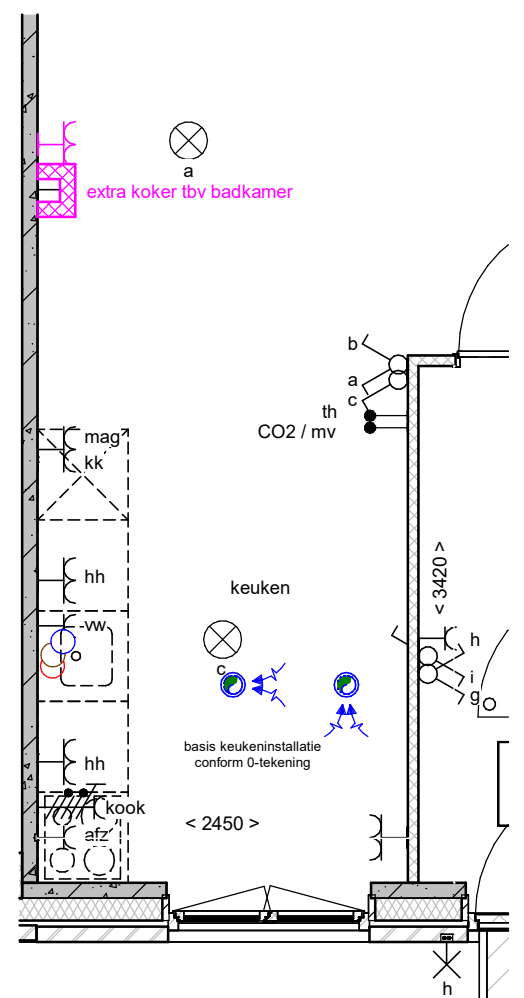

begane grond



Dura Vermeer Bouw Hengelo BV
 Bosmaatweg 60
 7556 PJ Hengelo
 Postbus 877
 7550 AW Hengelo
 Telefoon: (074) 255 02 55
 E-mail: hengelo.bouw@duravermeer.nl

tek. nr	: OT-12	fase	: 3b Verkoop
gezien	: JE	datum	: 26-03-2024
getekend	: MOM	gewijzigd	:
afmeting	: A3	wijzigingsnummer	:

project : **De Tippe X2**
 onderdeel: **badkamer verdieping 2 blok B en C**

schaal
 1:50
 status
 definitief
 projectnummer
 50183130

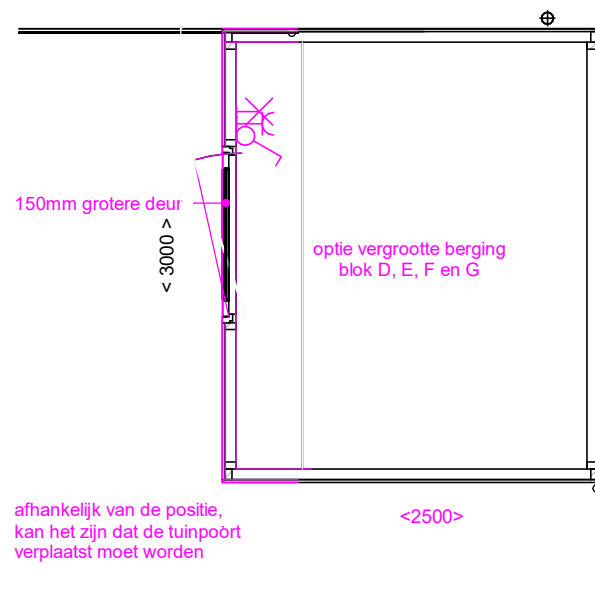
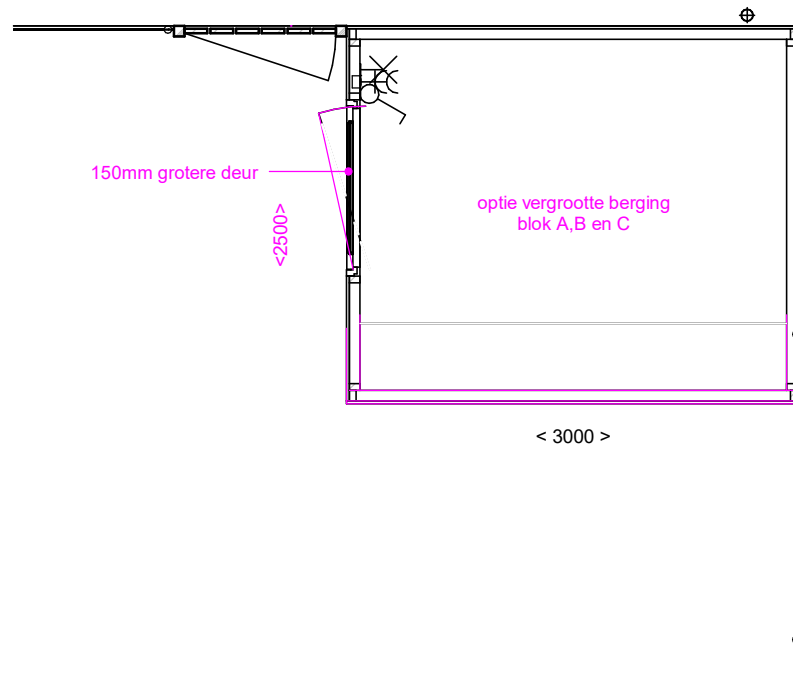

Dura Vermeer Bouw Hengelo BV
 Bosmaatweg 60
 7556 PJ Hengelo
 Postbus 877
 7550 AW Hengelo
 Telefoon: (074) 255 02 55
 E-mail: hengelo.bouw@duravermeer.nl

tek. nr	: OT-13	fase	: 3b Verkoop
gezien	: JE	datum	: 26-03-2024
getekend	: MOM	gewijzigd	:
afmeting	: A3	wijzigingsnummer	:

project : **De Tippe X2**
 onderdeel: **vergrootte berging blok A tm G**

schaal
 1:50
 status
 definitief
 projectnummer
 50183130

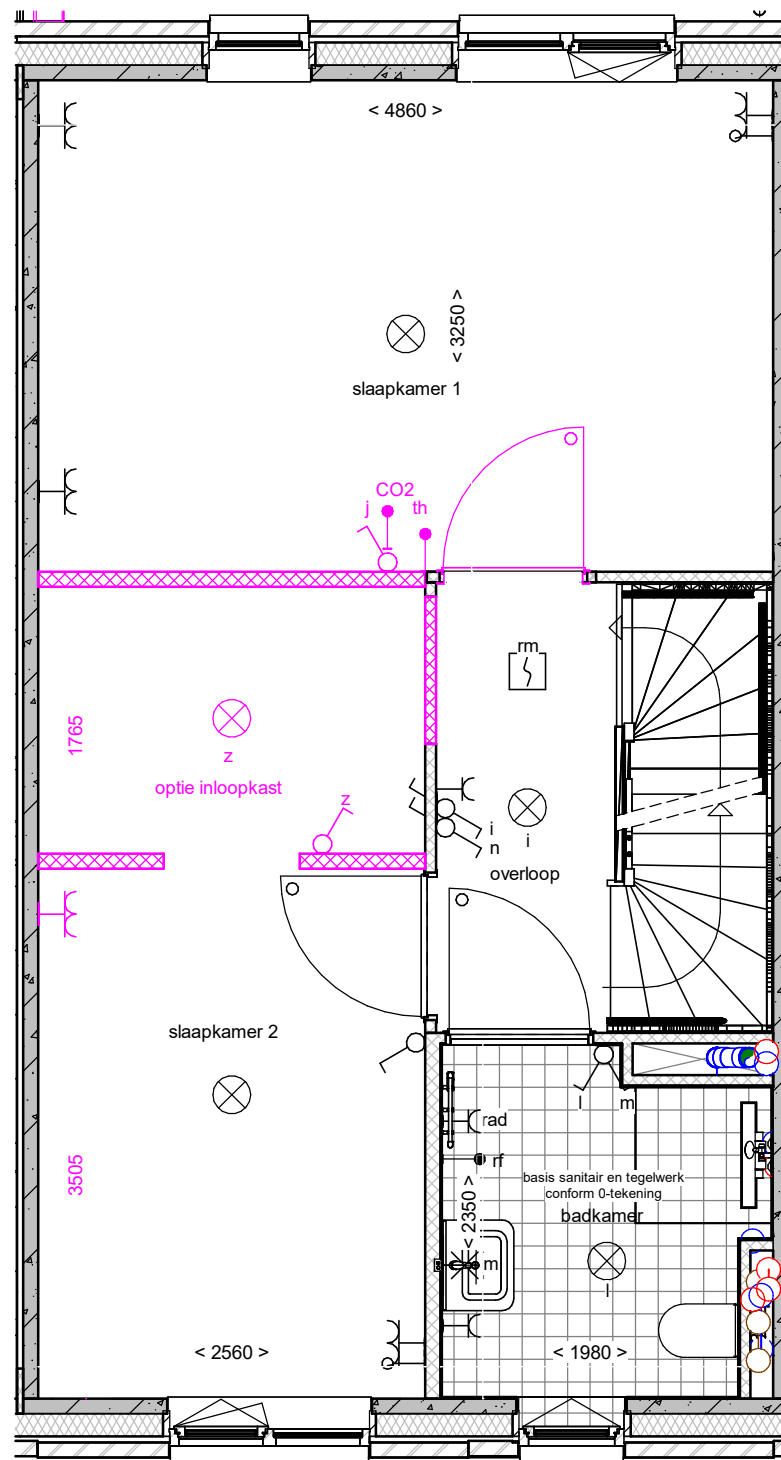
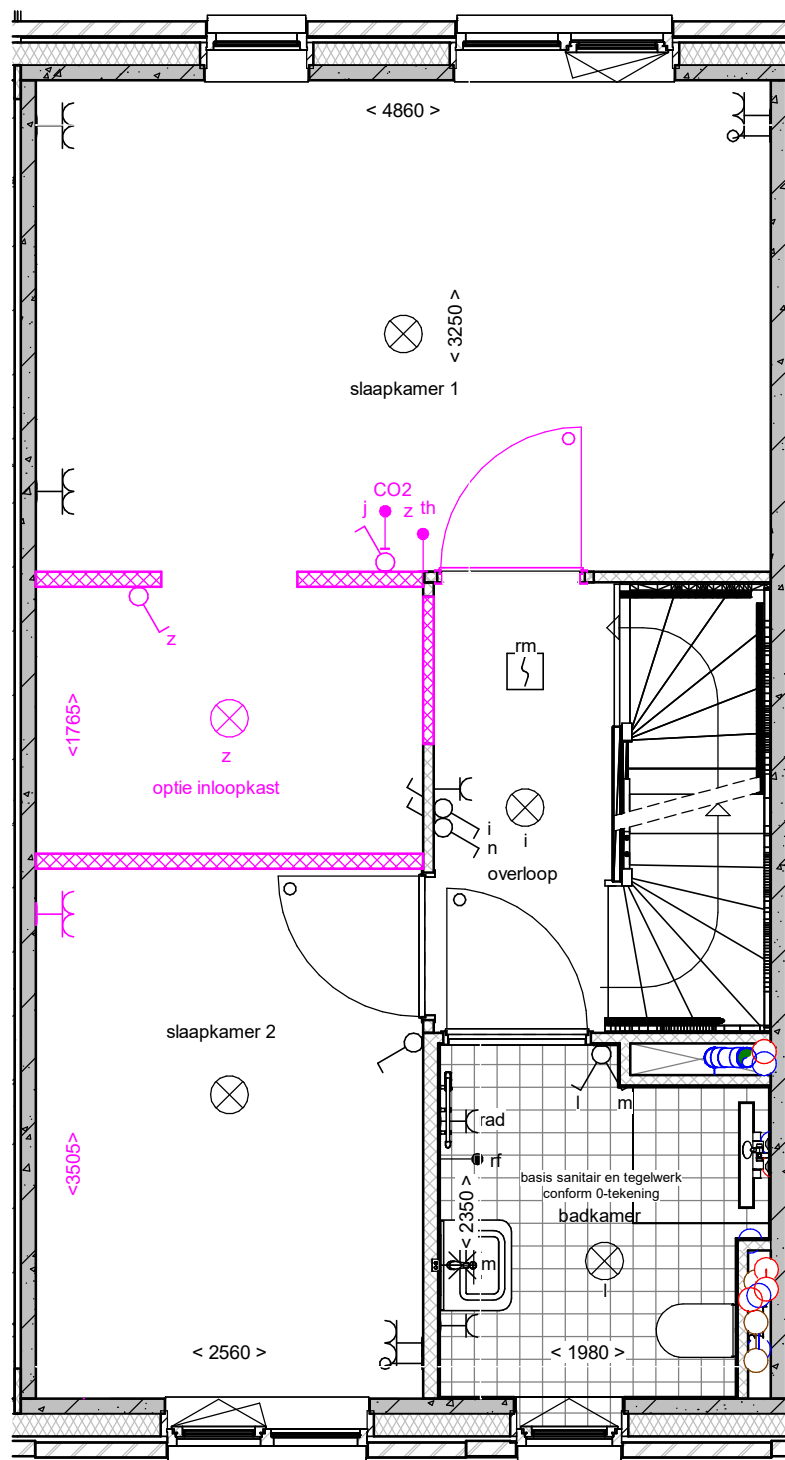

Dura Vermeer Bouw Hengelo BV
 Bosmaatweg 60
 7556 PJ Hengelo
 Postbus 877
 7550 AW Hengelo
 Telefoon: (074) 255 02 55
 E-mail: hengelo.bouw@duravermeer.nl

tek. nr : **OT-14** fase : **3b Verkoop**

gezien : JE datum : 26-03-2024

getekend : MOM gewijzigd :

afmeting : A3 wijzigingsnummer :

project : **De Tippe X2**
 onderdeel: **inloopkast slaapkamer 1**

schaal
1:50
 status
definitief
 projectnummer
50183130